

ARO®

PISTON PUMPS

4-BALL PUMP MODELS



4-Ball piston pumps are ideal solutions for higher volume and recirculation applications.

For over 85 years, the ARO® Fluid Products business of Ingersoll Rand has developed partnerships with more than 200 original equipment manufacturers and distributors, enabling us to better focus on the unique pumping needs of many industries. It is a strategic merger of our partners' application expertise, along with our decades-long legacy of designing and building outstanding piston pumps.

Piston pumps are the heartbeat that keeps material flowing through your most vital systems. When a steady stream is essential to your operation, it's important to trust products that can handle the pressure—that's where ARO comes in.

ARO offers a versatile range of piston pumps capable of meeting the specific needs of your specific application. Available in multiple configurations with a broad selection of pressure ratios and displacement rates, our pumps can help unlock superior performance and increase production across a number a unique applications.

Unmatched application expertise in:



Finishing



Coatings



Sealants and Adhesives



Bulk material transfer
and circulation



High-pressure cleaning



Lubrication



Simply better pumps

ARO LOWER PUMP END TECHNOLOGY

Whether your application requires a 2-ball, 4-ball, or chop-check piston pump, with ARO you get a pump that's better engineered, from the inside out. We offer design features and performance enhancements that ensure your pump is as durable and dependable as possible — maximizing output and minimizing downtime for a long time to come.

Pump selection made simple

With an ARO® piston pump, you can be assured of getting reliable equipment with the least amount of effort, calculation, or hassle on your part. There are basically four factors to take into consideration when selecting the right configuration for your application:

- ▶ Type of fluid
- ▶ Viscosity or thickness
- ▶ Required flow rate
- ▶ Required output pressure

Pump selection at a glance

Knowing fluid viscosity and flow rates makes it easier to choose the right pump for your application. Not sure what size air motor or piston pump you need? No problem. You can find out by calling ARO® Technical Support and working directly with our expert pump consultants, or by visiting our website to access specific pump performance data. Either way, you'll be sure to get a motor and pump package that operates efficiently, reliably, and safely.

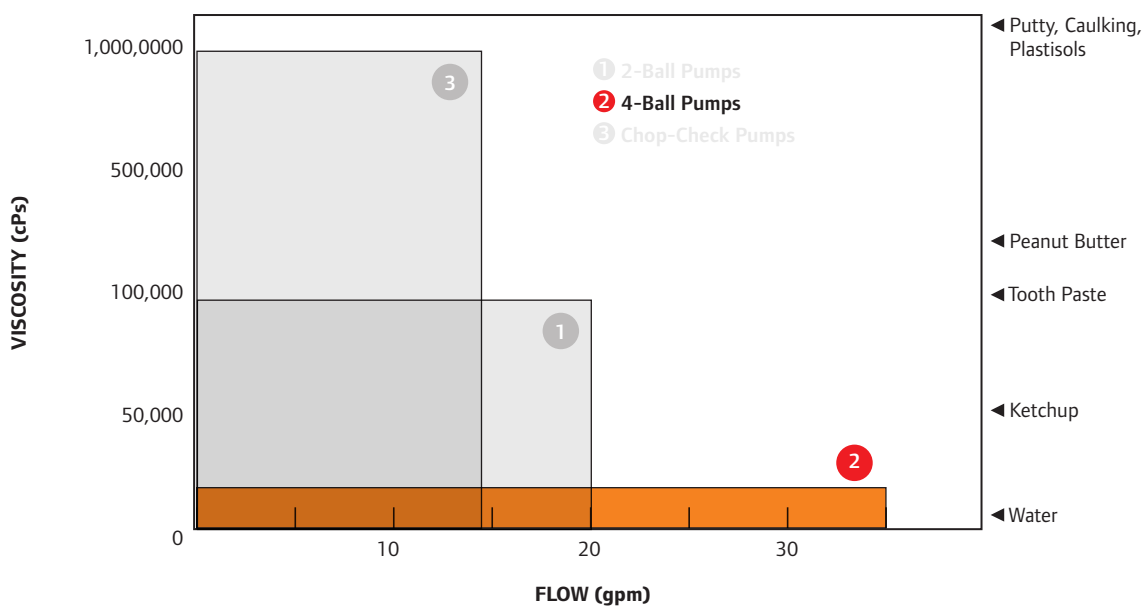

Best-in-class output

- Our 6" stroke delivers best-in-class displacement per cycle, delivering better flow rate, better output, and less fatigue on parts.

Easy serviceability

- Plungers and packings are easily accessible, minimizing downtime.
- Pump packings on the lower pumps are adjustable, featuring a wave spring and guide arrangement.
- Parts are available in convenient service kits so you have the right parts at the right time.

Superior performance with abrasive fluids

- Plunger rods and cylinder tubes feature a ceramic coating, extending service life up to twice as long. Available on 2-ball. Standard on 4-ball.
- Available in affordable **high-grade stainless-steel** construction.
- Electro-polished and passivated for material compatibility and corrosion-free operation.
- **Eight packing options** are available, including ultra-high molecular weight polyethylene (UHMW-PE), for even better material compatibility and excellent abrasion resistance.
- **Chrome-plated stainless steel plungers** for superior resistance to rust and corrosion.

Simply Versatile

4-ball piston pumps are designed to transfer high volumes of low- and medium-viscosity fluids up to 12,500 cPs with fluid delivery up to 32.8 gpm (124.0 L/min), depending on the application.

Applications advantages of 4-balls:



Transfer & Supply: 4-ball pumps are designed to move high volumes of fluids in order to minimize time spent filling or emptying large containers. The high flow rate is a result of double-acting pumping (draws material on the upstroke and downstroke) and is ideal for the large scale transfer of paints, chemicals, varnishes, enamels, lacquers and other low-to-medium viscosity fluids.

Another common application: circulating fluid from the original container to the point of use, and then back.

Materials advantages of 4-balls:

- ▶ **Corrosive materials:** ARO® 4-ball lower ends are constructed with stainless steel to maximize fluid compatibility with water based materials.
- ▶ **Abrasive materials:** A ceramic coating on the plunger rod and cylinder tube come standard on ARO® 4-ball pumps, protecting from highly abrasive materials and extending the service life of these parts up to 2x.

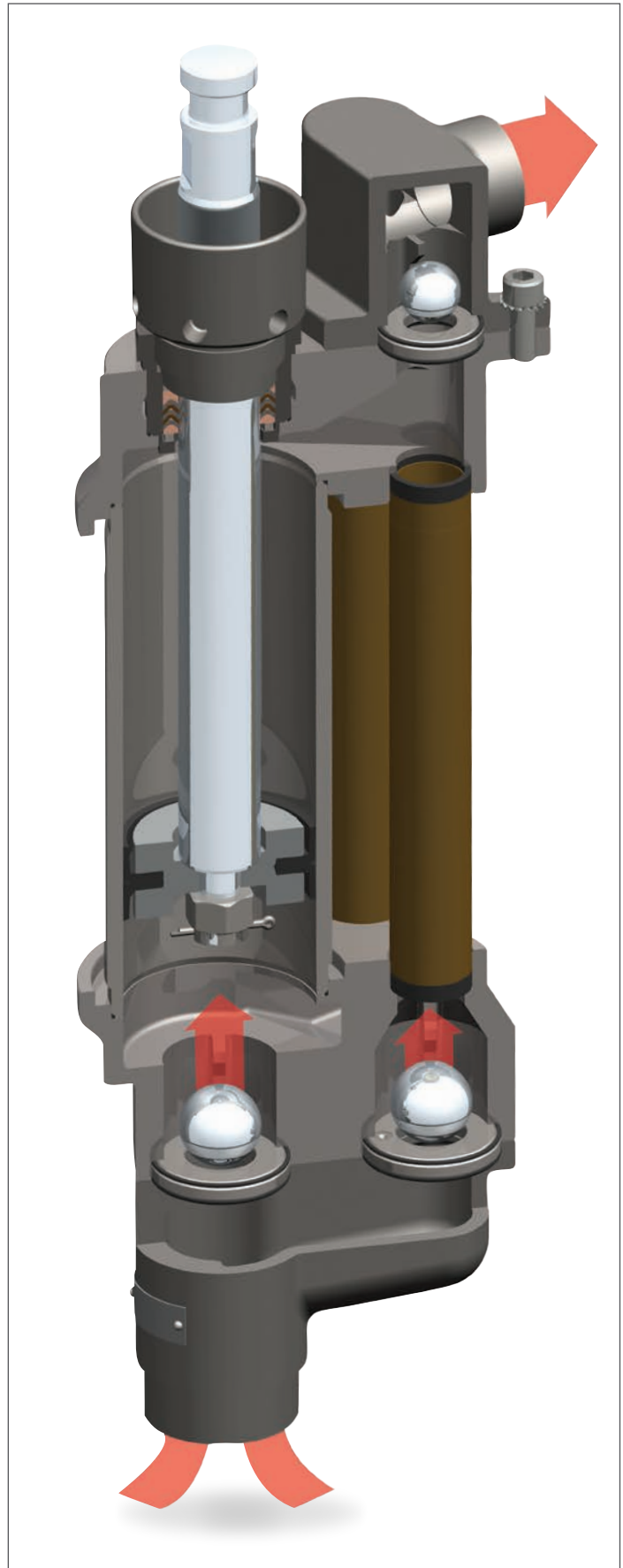

Selection Chart



See Page

2:1		21.3 gal/min 80.6 l/min	Stainless Steel	6
3:1		29.3 gal/min 110.8 l/min	Stainless Steel	7
4:1		21.3 gal/min 80.6 l/min	Stainless Steel	8
5:1		32.8 gal/min 124 l/min	St. Steel	9
7:1		23.5 gal/min 88.8 l/min	Stainless Steel	10

Viscosity Guide

Flow (gpm)	Maximum Delivery Rate gpm (L/min)	Ratio	Fluid Pressure Range psi (bar)	Pump Model Number	Material of Construction	Lower End Type	500 cPs	1,000 cPs	5,000 cPs	7,500 cPs	10,000 cPs	12,500 cPs
0 - 35	21.3 (80.6)	2:1	60 - 312 (4.1 - 21.5)	AF0402M11XXXX	Stainless Steel	4-Ball	Siphon	Flooded Inlet				
	21.3 (80.6)	4:1	120 - 633 (8.3 - 43.6)	AF0604M11XXXX	Stainless Steel	4-Ball	Siphon	Flooded Inlet				
	22.4 (84.8)	0.2:1 Hyd	10 - 278 (0.7 - 19.2)	650950-XXX	Stainless Steel	4-Ball	Siphon	Flooded Inlet				
	23.5 (89)	7:1	210 - 1009 (14.5 - 69.6)	AF0807M11XXXX	Stainless Steel	4-Ball	Siphon	Flooded Inlet				
	29.3 (110.9)	3:1	90 - 457 (6.2 - 31.5)	AF0603M11XXXX	Stainless Steel	4-Ball	Siphon	Flooded Inlet				
	32.8 (124.2)	5:1	150 - 702 (10.3 - 48.4)	AF0805M11XXXX	Stainless Steel	4-Ball	Siphon	Flooded Inlet				

2:1
4-1/4"

**AFX
Series**

AF0402 Series Pumps



(Model shown w/ ball valve regulator)

Materials: Paint, Chemicals, Varnishes, Enamels, Lacquers

Pump Specifications

Ratio	2:1
Stroke (double acting)	6" (15.24 cm)
Material Inlet	1-1/2" NPT(F)
Material Outlet	1" NPT(F)
Air Inlet (female)	1/2" NPT(F)
Air Inlet Pressure Range	30 - 150 (2.1 - 10.3)
Fluid Pressure Range	60 - 312 (4.1 - 21.5)
Max Cycles/Minute	60
Displacement/Cycle cu in (cm3)	82.1 (1345.3)
Cycles/gal (L)	2.8 (0.74)
Flow @ 60 Cycles gpm (L/min)	21.3 (80.6)
Noise Level @ 60 psi dBA	86.5
Weight* lb (kg)	68 (30.8)
Container Suitability	Remote Mounting

*Estimated weight. Contact Technical Support for exact weight.

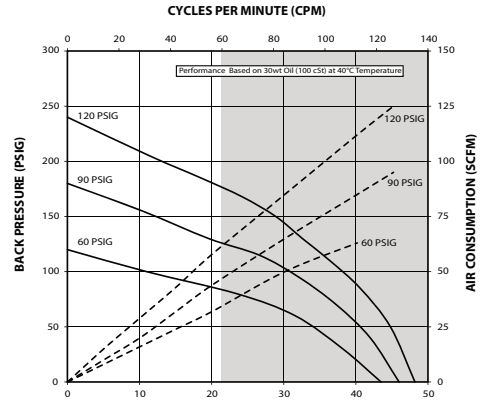

NON SHADED AREA OF THE GRAPH REPRESENTS RECOMMENDED OPERATING RANGE FOR CONTINUOUS DUTY

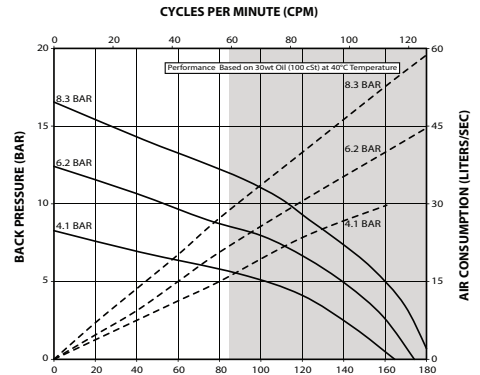

NON SHADED AREA OF THE GRAPH REPRESENTS RECOMMENDED OPERATING RANGE FOR CONTINUOUS DUTY

Pump Model**	Plunger Material	Upper Packings	Lower Packings	Lower Pump Model	Pump Service Kit
Lower Pump Model Material - 300 Series/CF8M Stainless Steel					
AF0402M11HF48	17-4 Stainless Steel, Ceramic Coated	UHMW-PE/Leather (Staggered)	UHMW-PE	67200-F4B	637317-F4B
AF0402M11RS48	17-4 Stainless Steel, Ceramic Coated	Glass Filled PTFE/UHMW-PE (Staggered)	Virgin PTFE	67200-R4B	637317-R4B
AF0402M11KS48	17-4 Stainless Steel, Ceramic Coated	Glass Filled PTFE	Virgin PTFE	67200-74B	637317-74B
AF0402M11FF48	17-4 Stainless Steel, Ceramic Coated	UHMW-PE	UHMW-PE	67200-C4B	637317-C4B

**Add "-1" to Model No. for Ball Valve Regulator

Recommended Accessories

DIMENSIONS

A1 in (mm)	45.27 (1149.76)
B in (mm)	21.99 (558.62)
C in (mm)	19.54 (496.32)

¹For models without ball valve regulator subtract 2.08 in (52.83 mm)



67445-1
Muffler Kit



66334-B
Wet-Sol Packing Lubricant



23644-400
ARO-Stop Valve



67187-1
Mounting Post



67442
Ball Valve Regulator



637489
Universal Air Motor Service Kit

3:1

6"

AFX
Series

AF0603 Series Pumps



(Model shown w/ ball valve regulator)

Materials: Paint, Chemicals, Varnishes,
Enamels, Lacquers

Pump Specifications

Ratio	3:1
Stroke (double acting)	6" (15.24 cm)
Material Inlet	1-1/2" NPT(F) 2" NPT(M)
Material Outlet	1" NPT(F)
Air Inlet (female)	1/2" NPT(F)
Air Inlet Pressure Range psi (bar)	30 - 150 (2.1 - 10.3)
Fluid Pressure Range psi (bar)	90 - 457 (6.2 - 31.5)
Max Cycles/Minute	60
Displacement/Cycle cu in (cm ³)	112.7 (1846.8)
Cycles/gal (L)	2.05 (0.54)
Flow @ 60 Cycles gpm (L/min)	29.3 (110.8)
Noise Level @ 60 psi dBA	84.7
Weight* lb (kg)	73.25 (33.2)
Container Suitability	Remote Mounting

*Estimated weight. Contact Technical Support for exact weight.

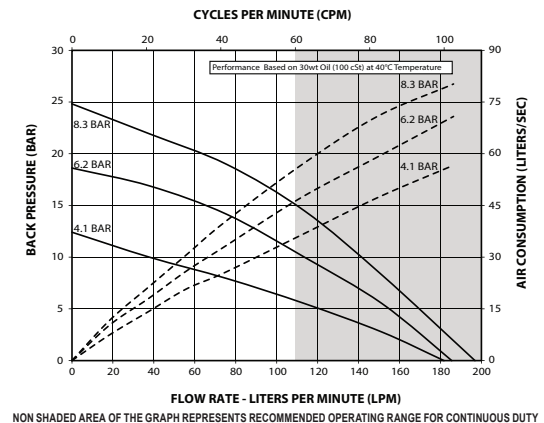
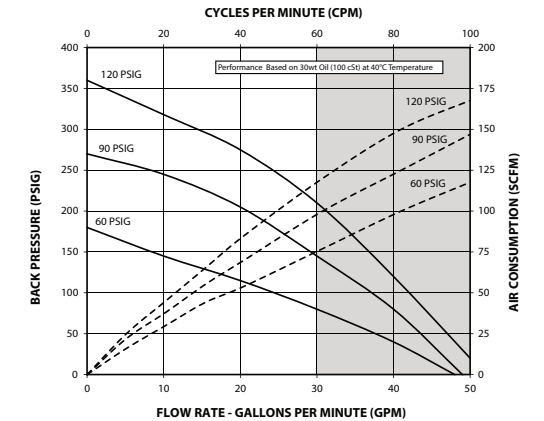

Pump Model**	Plunger Material	Upper Packings	Lower Packings	Lower Pump Model	Pump Service Kit
Lower Pump Material - 300 Series/CF8M Stainless Steel					
AF0603M11FF48	17-4 Stainless Steel, Ceramic Coated	UHMW-PE	UHMW-PE	67201-C4B	637318-C4B
AF0603M11KS48	17-4 Stainless Steel, Ceramic Coated	Glass Filled PTFE	Virgin PTFE	67201-74B	67318-74B
AF0603M11HF48	17-4 Stainless Steel, Ceramic Coated	UHMW-PE/Leather (Staggered)	UHMW-PE	67201-F4B	67318-F4B
AF0603M11RS48	17-4 Stainless Steel, Ceramic Coated	Glass Filled PTFE/UHMW-PE (Staggered)	Virgin PTFE	67201-R4B	67318-R4B
AF0603M11GF48	17-4 Stainless Steel, Ceramic Coated	UHMW-PE/Glass Filled PTFE (Staggered)	UHMW-PE	67201-P4B	67318-P4B

**Add "-1" to Model No. for Ball Valve Regulator

Recommended Accessories



67445-2
Muffer Kit



66334-B
Wet-Sol Packing
Lubricant



23644-400
ARO-Stop
Valve



67187-1
Mounting Post



67442
Ball Valve
Regulator



637489
Universal Air Motor
Service Kit

DIMENSIONS

A1 in (mm)	45.27 (1149.76)
B in (mm)	21.99 (558.62)
C in (mm)	19.54 (496.32)

¹For models without ball valve regulator subtract 2.08 in (52.83 mm)

4:1

6"

AFX
Series

AF0604 Series Pumps



(Model shown w/ball valve regulator)

Materials: Paint, Chemicals, Varnishes,
Enamels, Lacquers

Pump Specifications

Ratio	4:1
Stroke (double acting)	6" (15.24 cm)
Material Inlet	1-1/2" NPT(F)
2" NPT(M)	
Material Outlet	1" NPT(F)
Air Inlet (female)	1/2" NPT(F)
Air Inlet Pressure Range	30 - 150
psi (bar)	(2.1 - 10.3)
Fluid Pressure Range	120 - 633
psi (bar)	(8.3 - 43.7)
Max Cycles/Minute	60
Displacement/Cycle cu in (cm ³)	82.1 (1345.3)
Cycles/gal (L)	2.8 (0.74)
Flow @ 60 Cycles gpm (L/min)	21.3 (80.6)
Noise Level @ 60 psi dBA	84.7
Weight* lb (kg)	71.25 (32.3)
Container Suitability	Remote Mounting

*Estimated weight. Contact Technical Support for exact weight.

PERFORMANCE BASED ON 30wt. OIL (100 cSt) AT 40° C TEMPERATURE
CYCLES PER MINUTE (CPM)

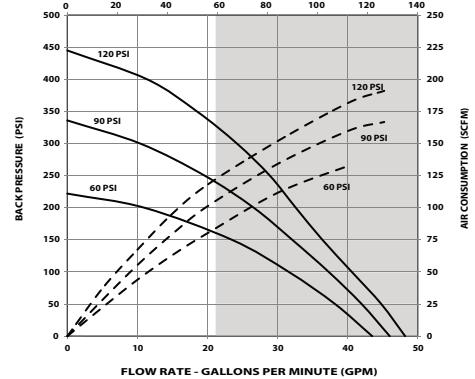

NON SHADED AREA OF THE GRAPH REPRESENTS RECOMMENDED OPERATING RANGE FOR CONTINUOUS DUTY

PERFORMANCE BASED ON 30wt. OIL (100 cSt) AT 40° C TEMPERATURE
CYCLES PER MINUTE (CPM)

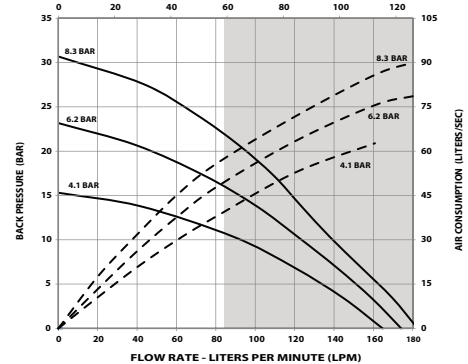

NON SHADED AREA OF THE GRAPH REPRESENTS RECOMMENDED OPERATING RANGE FOR CONTINUOUS DUTY

Pump Model**	Plunger Material	Upper Packings	Lower Packings	Lower Pump Model	Pump Service Kit
Lower Pump Model Material - 300 Series/CF8M Stainless Steel					
AF0604M11FF48	17-4 Stainless Steel, Ceramic Coated	UHMW-PE	UHMW-PE	67200-C4B	637317-C4B
AF0604M11KS48	17-4 Stainless Steel, Ceramic Coated	Glass Filled PTFE	Virgin PTFE	67200-74B	637317-74B
AF0604M11HF48	17-4 Stainless Steel, Ceramic Coated	UHMW-PE/Leather (Staggered)	UHMW-PE	67200-F4B	637317-F4B
AF0604M11GF48	17-4 Stainless Steel, Ceramic Coated	UHMW-PE/Glass Filled PTFE (Staggered)	UHMW-PE	67200-P4B	637317-P4B
AF0604M11RS48	17-4 Stainless Steel, Ceramic Coated	Glass Filled PTFE/UHMW-PE (Staggered)	Virgin Teflon	67200-R4B	637317-R4B

**Add "-1" to Model No. for Ball Valve Regulator

DIMENSIONS

A1 in (mm)	45.27 (1149.76)
B in (mm)	21.99 (558.62)
C in (mm)	19.54 (496.32)

¹For models without ball valve regulator subtract 2.08 in (52.83 mm)

Recommended Accessories



67445-2
Muffler Kit



66334-B
Wet-Sol Packing
Lubricant



23644-400
ARO-Stop
Valve



67187-1
Mounting Post



67442
Ball Valve
Regulator



637489
Universal Air Motor
Service Kit

5:1

8"

AFX
Series

AF0805 Series Pumps



Materials: Paint, Chemicals, Varnishes, Enamels, Lacquers

Pump Specifications

Ratio	5:1
Stroke (double acting)	6" (15.24 cm)
Material Inlet	1-1/2" NPT(F) 2" NPT(M)
Material Outlet	1" NPT(F)
Air Inlet (female)	3/4" NPT(F)
Air Inlet Pressure Range psi (bar)	30 - 120 (2.1 - 8.3)
Fluid Pressure Range psi (bar)	150 - 702 (10.3 - 48.4)
Max Cycles/Minute	60
Displacement/Cycle cu in (cm ³)	108.1 (1771.4)
Cycles/gal (L)	2.1 (0.5)
Flow @ 60 Cycles gpm (L/min)	32.8 (124.0)
Noise Level @ 60 psi dBA	86.8
Weight* lb (kg)	96 (43.5)
Container Suitability	Remote Mounting

*Estimated weight. Contact Technical Support for exact weight.

(Model shown w/ball valve regulator)

DIMENSIONS

A ¹ in (mm)	48.73 (1237.72)
B in (mm)	25.67 (652.12)
C in (mm)	19.54 (496.32)

¹For models without ball valve regulator subtract 2.08 in (52.83 mm)

PERFORMANCE BASED ON 30wt. OIL (100 cSt) AT 40° C TEMPERATURE
CYCLES PER MINUTE (CPM)

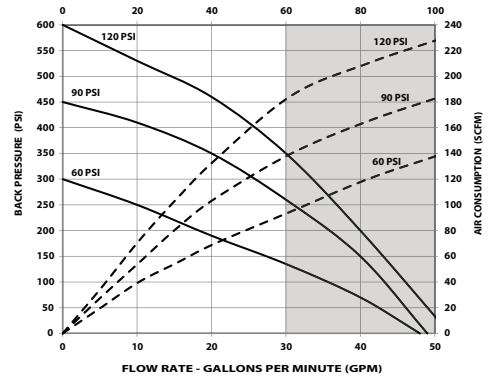

PERFORMANCE BASED ON 30wt. OIL (100 cSt) AT 40° C TEMPERATURE
CYCLES PER MINUTE (CPM)

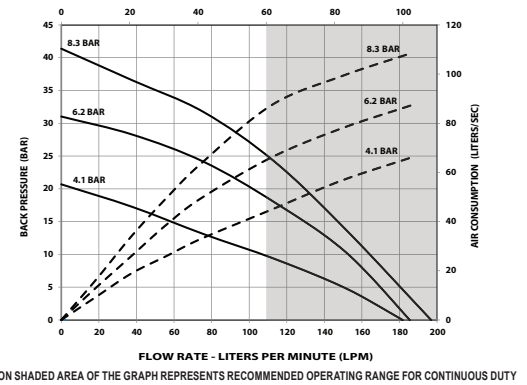

Pump Model**	Plunger Material	Upper Packings	Lower Packings	Lower Pump Model	Pump Service Kit
Lower Pump Model Material - 300 Series/CF8M Stainless Steel					
AF0805M11FF48	17-4 Stainless Steel, Ceramic Coated	UHMW-PE	UHMW-PE	67201-C4G	637318-C4G
AF0805M11GF48	17-4 Stainless Steel, Ceramic Coated	UHMW-PE/Glass Filled PTFE (Staggered)	UHMW-PE	67201-P4G	637318-P4G

**Add "-1" to Model No. for Ball Valve Regulator

Recommended Accessories



67445-3
Muffler Kit



66334-B
Wet-Sol Packing Lubricant



23644-400
ARO-Stop Valve



67187-1
Mounting Post



67442
Ball Valve Regulator



637489
Universal Air Motor Service Kit

7:1

8"

AFX
Series

AF0807 Series Pumps



(Model shown w/ball valve regulator)

Materials: Paint, Chemicals, Varnishes,
Enamels, Lacquers

Pump Specifications

Ratio	7:1
Stroke (double acting)	6" (15.24 cm)
Material Inlet	1-1/2" NPT(F)
2" NPT(M)	
Material Outlet	1" NPT(F)
Air Inlet (female)	3/4" NPT(F)
Air Inlet Pressure Range	30 - 120
psi (bar)	(2.1 - 8.3)
Fluid Pressure Range	210 - 1009
psi (bar)	(14.5 - 69.6)
Max Cycles/Minute	60
Displacement/Cycle cu in (cm ³)	82.1 (1345)
Cycles/gal (L)	2.8 (0.7)
Flow @ 60 Cycles gpm (L/min)	23.5 (88.8)
Noise Level @ 60 psi dBA	86.8
Weight* lb (kg)	94 (42.6)
Container Suitability	Remote Mounting

*Estimated weight. Contact Technical Support for exact weight.

PERFORMANCE BASED ON 30wt. OIL (100 cSt) AT 40° C TEMPERATURE
CYCLES PER MINUTE (CPM)

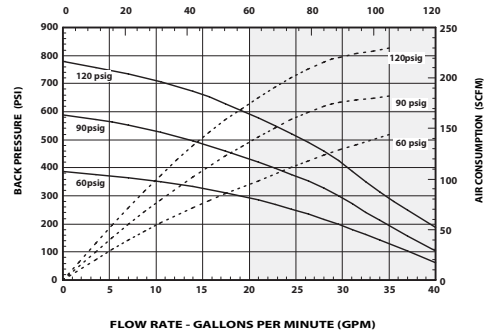

PERFORMANCE BASED ON 30wt. OIL (100 cSt) AT 40° C TEMPERATURE
CYCLES PER MINUTE (CPM)

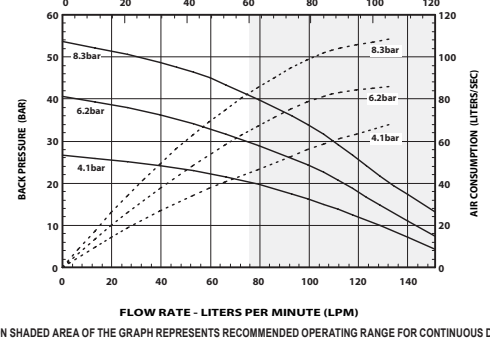

Pump Model**	Plunger Material	Upper Packings	Lower Packings	Lower Pump Model	Pump Service Kit
Lower Pump Model Material - 300 Series/CF8M Stainless Steel					
AF0807M11FF48	17-4 Stainless Steel, Ceramic Coated	UHMW-PE	UHMW-PE	67200-C4G	637317-C4G
AF0807M11KS48	17-4 Stainless Steel, Ceramic Coated	Glass Filled PTFE	Virgin PTFE	67200-74G	637317-74G
AF0807M11RS48	17-4 Stainless Steel, Ceramic Coated	Glass Filled PTFE/ UHMW-PE (Staggered)	Virgin PTFE	67200-R4G	637317-R4G
AF0807M11HF48	17-4 Stainless, Ceramic Coated	UHMW-PE/Leather (Staggered)	UHMW-PE	67200-F4G	637317-F4G

**Add "-1" to Model No. for Ball Valve Regulator

Recommended Accessories



67445-3
Muffler Kit



66334-B
Wet-Sol Packing
Lubricant



23644-400
ARO-Stop
Valve



67187-1
Mounting Post



67442
Ball Valve
Regulator



637489
Universal Air Motor
Service Kit

DIMENSIONS

A ¹ in (mm)	48.73 (1237.72)
B in (mm)	25.67 (652.12)
C in (mm)	19.54 (496.32)

¹For models without ball valve regulator subtract 2.08 in (52.83 mm)

Distributed by:

www.AROzone.com

arotechsupport@irco.com

youtube.com/aropumps

(800) 495-0276



About Ingersoll Rand

Ingersoll Rand Inc. (NYSE:IR), driven by an entrepreneurial spirit and ownership mindset, is dedicated to helping make life better for our employees, customers and communities. Customers lean on us for our technology-driven excellence in mission-critical flow creation and industrial solutions across 40+ respected brands where our products and services excel in the most complex and harsh conditions. Our employees develop customers for life through their daily commitment to expertise, productivity and efficiency. For more information, visit www.IRco.com.

We are committed to using environmentally conscious print practices

©2016 Ingersoll Rand

IRITS-0916-177 EN 0719